

Energy Reduction of CO₂ Capture by New Absorbents Development

HSUN-YU LIN and CHUN-HSIU WANG

*New Materials Research & Development Department
China Steel Corporation*

Reducing carbon dioxide (CO₂) emission is one of the major challenges for the world's steel industries. Carbon capture and storage (CCS) is now widely recognized as an option that could contribute almost 20% to the total emissions reductions. Among the several existing technologies for carbon capture, chemical absorption was chosen to capture CO₂ from the hot stove gas at China Steel (CSC). A self-designed carbon capture pilot plant has been constructed and tested at CSC. The capture efficiency and capture capacity of CO₂ have achieved the design targets; however, the energy consumption for carbon capture are still above the directive of the European Union issued in 2005. Five absorbents, comprising 20%AMP+10%PZ solution, 20%DETA+10%PZ solution, 23%DETA+20%PZ solution, 20% MEA solution and 30% MEA solution, were chosen to investigate their CO₂ capture properties and to search for the optimal operating parameters to reduce the regeneration energy of CO₂ capture. At the present stage, the optimal reboiler duty can be reduced to 5.3 GJ/ton CO₂ by using 23%DETA+10%PZ solution as the absorbent at a solvent flow rate of 100 kg/hr.

Keywords: Carbon capture, Hot stove, Energy consumption, Absorbent

1. INTRODUCTION

Global warming has become a global concern for environmental, scientific, political and economic issues. Carbon dioxide is regarded as the largest contributor to the greenhouse effect among all the greenhouse gases. The concentration of CO₂ in the atmosphere has increased by approximately 100 parts per million by volume (ppmv) over the past 100 years, having stood at 280 ppmv in 1860^(1,2). The International Energy Agency (IEA) publication Energy Technology Perspectives 2010 (ETP) projects that in 2050, energy-related CO₂ emissions will be two times the 2007 level in the absence of any new energy policies or supply constraints, due primarily to increased fossil fuel usage and a rise in the carbon intensity of primary energy⁽³⁾. According to the Fourth Assessment Report of the Intergovernmental Panel on Climate Change (IPCC), the global CO₂ emissions in 2050 should be reduced at least 50% compared with the 2000 level in order to achieve an atmospheric temperature drop below around 2°C and an emissions reduction of 450 ppmv-CO_{2eq}⁽⁴⁾. Carbon Capture and Storage (CCS) is now widely recognized as an option that could contribute almost 20% to the total emissions reductions, in addition to other measures like energy efficiency improvements,

the use of renewable energy sources, and nuclear energy^(5,6). The typical cost of creating an emission reduction through the use of CCS is currently around 50–100 US\$/ton CO₂⁽⁷⁾. The cost is higher than the current price of the carbon market; however, the expected or desirable carbon price is much higher than the cost of CCS for achieving emission reductions.

Power generation from fossil fuel-fired power plants (e.g., coal and natural gas) is the single largest source of CO₂ emissions in Taiwan, followed by the petrochemical industry and the steel industry. The Taiwan Environmental Protection Administration (EPA) has decreed that the CO₂ emissions in 2020 should be reduced to the 2005 level and that the CO₂ emissions in 2025 should be reduced to the 2000 level as the targets for CO₂ reduction in Taiwan. China Steel (CSC) is the biggest steel-making corporation in Taiwan and produces approximately 10 million tonnes of crude steel annually, adding 20 million tonnes of CO₂ emissions to the atmosphere annually. Reducing CO₂ emission has become one of the major challenges for CSC.

CCS has been promoted and announced to be one of the government projects. CSC is one of the key members for performing National CCS projects and is responsible for the carbon capture research. Several

existing technologies, such as chemical absorption, physical absorption, physical adsorption, and the use of membranes, have been proposed to capture CO₂ from gases⁽¹⁾. Among these technologies, the chemical absorption method using amine based absorbents is the most applicable to the post-combustion CO₂ capture process in thermal power station.

Traditional amines such as monoethanolamine (MEA) and amine blends such as potassium carbonate (K₂CO₃)/piperazine (PZ) and methyldiethanolamine (MDEA)/PZ have been investigated extensively for this application⁽⁸⁻¹⁰⁾. Amines can be classified as primary, secondary or tertiary depending on the degree of substitution of the nitrogen atom. Primary and secondary alkanolamines react rapidly with CO₂ to form carbamates. Tertiary alkanolamines do not possess a hydrogen atom attached to the nitrogen atom. Therefore, they facilitate a CO₂ hydrolysis reaction to form bicarbonates. The heat of reaction involved with bicarbonate formation is lower than that of carbamate formation and thus tertiary amines like MDEA are often blended with primary or secondary amines to reduce solvent regeneration costs. Sterically hindered amines are primary and secondary amines modified to reduce regeneration costs⁽¹⁾.

The biggest point at issue of chemical absorption is the high regeneration of energy. To make this process more practical in the near future, it is essential to reduce the regeneration energy⁽¹¹⁾. Many of the research groups have attempted to develop new types of chemical absorbents for the enhancement of conventional alkanolamine absorbents, especially MEA. Therefore, the objective of this study was to develop

new absorbents to reduce regeneration energy in the carbon capture process.

2. EXPERIMENTAL METHOD

2.1 Construction of CO₂ capture pilot plant

A self-designed carbon capture pilot plant has been constructed and tested at CSC. This pilot plant based on chemical absorption is the first CO₂ capture pilot plant in Taiwan and is set up beside the #3 BF hot stove at CSC. The CO₂ capture process consists of an absorber, a stripper and a cross heat exchanger. Its flow sheet was shown in Fig.1. The BF hot stove gas was chosen to perform the CO₂ capture experiments. Its temperature and pressure are about 400 K and 0.1 MPa, respectively. This gas stream contains about 28.4 vol% of CO₂, 70 vol% of N₂, 1.3 vol% of O₂, 22 ppm of SO_x, and 16 ppm of NO_x, all in dry basis. The CO₂ content emitted from a steel plant is obviously different from that in the flue gases of power plants, which vary from 3 to 15 vol% depending on the fossil fuel used. In the steel plant situation, there is a need to develop a CO₂ capture process specifically suitable for the treatment of hot stove gas.

Currently, the feed gas from the #3 BF hot stove is put into contact with a lean solvent in an absorber unit. Gas with a reduced CO₂ content is emitted from the top of the absorption tower, while the rich solvent, loaded with CO₂, remains at the bottom of the tower from where it is then heated in a cross heat exchanger before being sent to the stripper for CO₂ stripping from the solvent. The CO₂ is released at the top of the stripper while the lean solvent is recycled back to the absorber. A current recorder was installed in the pilot plant to

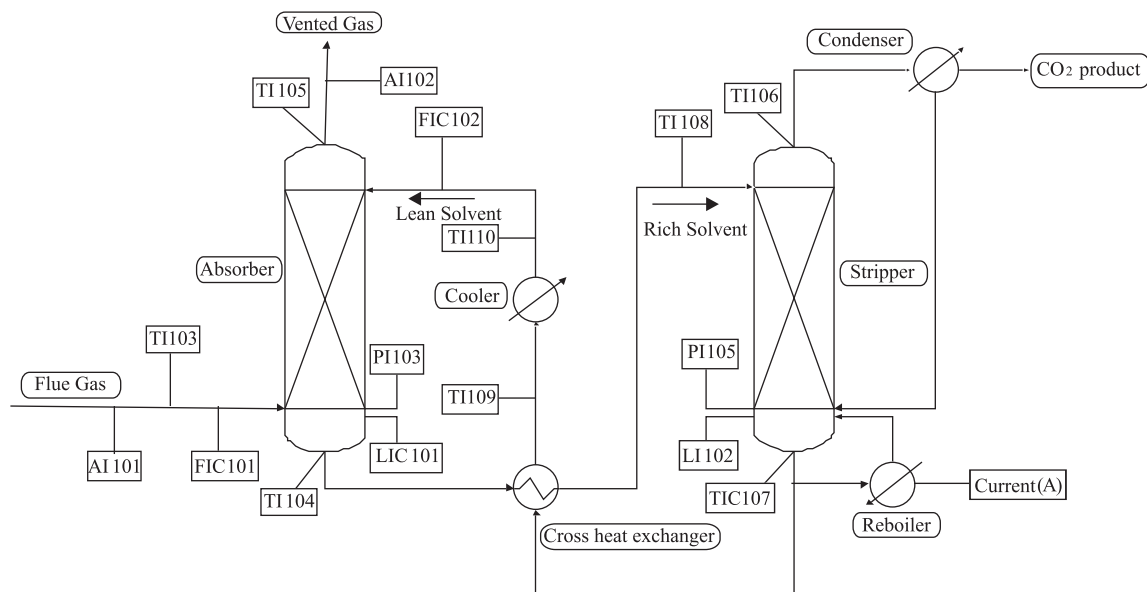
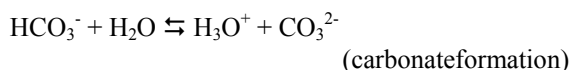
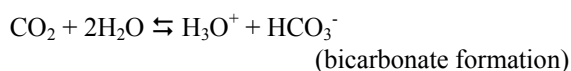
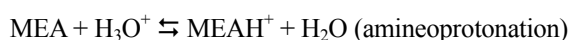

Fig.1. CO₂ capturing process flow sheet.

store input energy for calculating the reboiler duty. The pilot plant can capture 100 kg CO₂/day with the efficiency higher than 90%.

2.2 Development of MEA model

MEA solution is an effective solvent that has been widely used commercially in CO₂ removal plants. Simulation of a dynamic MEA absorption process model is necessary to simulate and optimize the MEA-based CO₂ capture system. In this study, simulations were performed using the ASPEN software. The reactive absorption of the CO₂–MEA–H₂O system is complex because of the multiple equilibrium and kinetic reversible reactions. The equilibrium reactions included in this model are:



The reaction model to be used in the absorber and the stripper is made consistent with the Electrolyte-NRTL thermodynamic model and the reactions were the same as in the base case.

Equilibrium reaction:

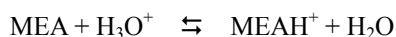
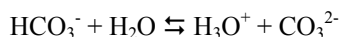
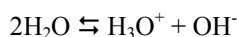

Kinetic reactions:

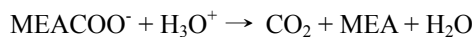
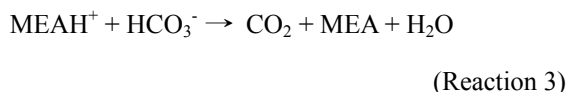

(Reaction 4)

The kinetic expression defined in ASPEN Plus is temperature-dependent and can be expressed as follows:

$$r = k(T/T_0)^n \exp\left(-\frac{E}{R}\left(\frac{1}{T} - \frac{1}{T_0}\right)\right)$$

The kinetic parameters for the above reactions are summarized in Table 1.

An ASPEN Plus design specification measured the CO₂ flow rate in the stack stream and adjusted the lean solvent flow rate to ensure that a target recovery of 90% was achieved. However, the effect of SO_x and NO_x on reboiler duty was not considered in the simulation.

2.3 Parametric optimization of various absorbents in CO₂ capture system

Concentrated aqueous PZ, classified as a tertiary amine, has been identified as a better solvent for CO₂ capture than other amines due to its greater rate of CO₂ absorption and greater CO₂ capacity. However, PZ has certain disadvantages as a CO₂ absorbent. Pure PZ is only soluble in water up to 1.9 mol/kg water. Freeman et al. have shown that, for 8 m PZ at room temperature, precipitation occurred when CO₂ loading is less than 0.2 mol CO₂/mol alkalinity (One mol amino group is equivalent to 1 mol alkalinity)⁽¹²⁾. In addition, 2-amino-2-methyl-1-propanol (AMP) was considered as an efficient CO₂ absorbent due to its advantages over conventional amines. In comparison to MEA, AMP has a higher loading capacity of 1 mol of CO₂/mol of AMP. However, AMP is not a stable absorbent and its degradation rate strongly depended on O₂ partial pressure and CO₂ loading⁽¹³⁾. In order to improve the disadvantages of PZ and AMP, different amines are blended to form mixture solutions which are expected to exhibit lower reboiler duty in CO₂ capture than MEA.

Five absorbents, comprising 20%AMP+10%PZ solution, 20%DETA+10%PZ solution, 23%DETA+20% PZ solution, 20% MEA, and 30% MEA, were chosen to investigate their CO₂ capture properties. Various operating parameters including solvent flow rate, stripper temperature, and stripper pressure, were

Table 1 Kinetic parameters (Activity based)

Parameter	Reaction 1	Reaction 2	Reaction 3	Reaction 4
k	4.32E+13	2.38E+17	9.77E+10	2.18E+18
n	0	0	0	0
E (KJ/Kmol)	1.32E+04	2.95E+04	9.86E+03	1.41E+04
T ₀ (K)	298	298	298	298

investigated to search for the optimal reboiler duty. All experiments performed in this study were based on at least 90% CO₂ capture efficiency. All chemicals employed in this study were of analytical reagent grade and used as supplied without further purification.

3. RESULTS AND DISCUSSION

3.1 Simulation of MEA absorption model

Figure 2 presents the influence of MEA concentration and solvent flow rate on reboiler duty at a stripper pressure of 1 atm calculated by ASPEN software with an equilibrium model. Simulation results show that the reboiler duty decreases with an increase of MEA concentration. A higher MEA concentration can capture more CO₂ than a lower MEA concentration over the same absorption time and solvent flow rate even though

the former need more energy to regenerate the same volume of solvent. In addition, simulation results also depict that an optimal reboiler duty exists at certain flow rate for a certain MEA concentration. As shown in Fig.2, the increase in the reboiler duty to the left of the optimal solvent flow rate is related to the high amount of stripping energy needed to obtain the required low lean loading. The increase in the reboiler duty to the right of the optimal solvent flow rate is due to the energy requirement to heat up the higher solvent flows. The simulation results show that the optimal reboiler duty for 20% MEA is approximately 8.9 GJ/ton CO₂ at a solvent flow rate of 210 kg/hr while it is 4.5 GJ/ton CO₂ at a solvent flow rate of 134 kg/hr for 30% MEA.

Figure 3 shows the influence of the stripping pressure on reboiler duty. The reboiler duty of the stripper

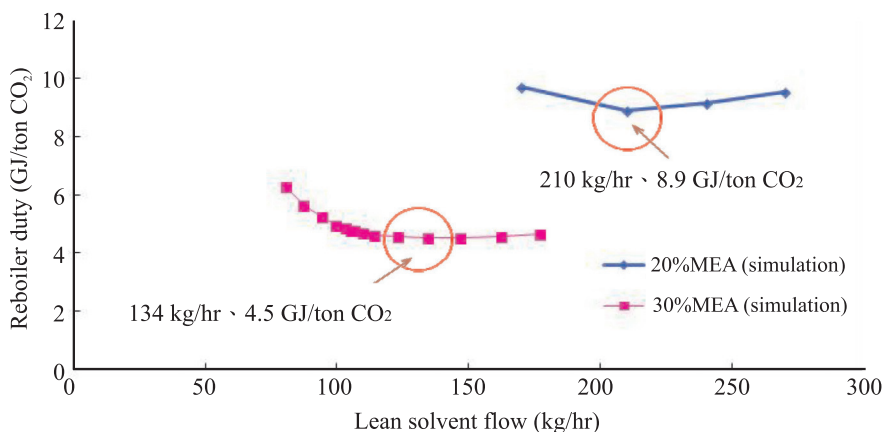

Fig.2. Influence of MEA concentration and solvent flow rate on reboiler duty. (Stripper pressure: 1 atm)

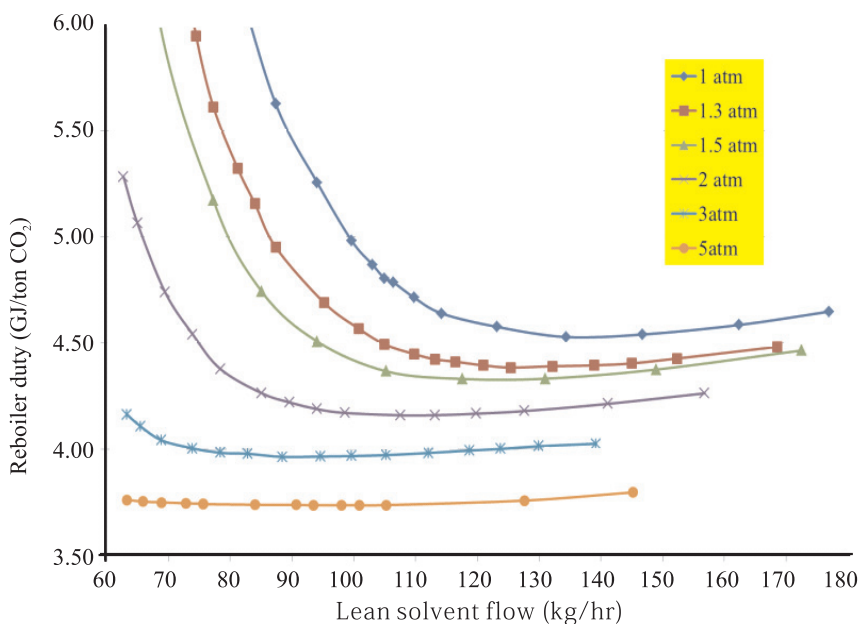

Fig.3. Simulated results of reboiler duty at various stripper pressures for 30% MEA.

decreases with an increase of the stripper pressure from 1 to 5 atm. The energy provided to the reboiler is employed to heat the rich MEA solution entering the stripper, to drive the MEA–CO₂ desorption reaction and to vaporize water to generate stripping vapor (steam). The stripping column at CSC is normally operated in 1 atm, at a temperature of around 101~105°C depending on the MEA concentration. As the stripping pressure is increased, the operating temperature also increases. As the stripper operating temperature increases, the ratio of the partial pressure of water to that of CO₂, (P_{H_2O}/P_{CO_2}), in equilibrium with the MEA solution decreases and results in a decreased stripping vapor (steam) requirement. Since, in this case, the stripping vapor is steam, an increased stripper pressure results in a decrease in the total reboiler duty⁽¹²⁾. This tendency was also found in several published literatures^(14,15).

3.2 CO₂ capture of MEA

The CO₂ capture experiments performed in the pilot plant are discussed in this section. The operating parameters, comprising solvent flow rate, stripper temperature, and stripper pressure, are set up with reference to the simulation data.

3.2.1 Effect of MEA concentration on reboiler duty

Referring to the simulated results as discussed in Fig.2, various close to optimal solvent flow rates were chosen to investigate the effect of MEA concentration on reboiler duty and the experimental results are shown in Fig.4. These results indicated that the lowest reboiler duty appears at the solvent flow rate of 210 kg/hr for 20% MEA, while the lowest reboiler duty appears at the solvent flow rate of 105 kg/hr for 30% MEA. In this study, the lowest reboiler duty for 20% MEA and 30% MEA were found to be 8.2 and 5.8 GJ/ton CO₂, respectively.

3.2.2 Effect of stripper pressure on reboiler duty

As discussed in section 3.1, stripping pressure is one of key factors associated with the reboiler duty. Table 2 presents the variations of reboiler duty under the stripping pressures from 1 to 1.5 atm. In this study, 30% MEA was used as the absorbent and its flow rate was set up at 105 kg/hr. Experimental results show that the optimal reboiler duty obviously decreased from 6.28 to 6.02 GJ/ton CO₂ with an increase of stripping pressure from 1 to 1.5 atm. The results predict that raising the stripping pressure is highly effective in reducing the reboiler duty for the CO₂ capture process.

3.3 Effects of absorbent types on reboiler duty

Figure 5 shows the effect of various absorbents on the reboiler duty. The experimental results show that the reboiler duty of 20%DETA+10%PZ and 23%DETA+10%PZ solutions are superior to MEA solution. This implies that the blending of different amines can reduce reboiler duty. In addition, the 23%DETA+20%PZ solution exhibits a lower reboiler duty than the 20%DETA+10%PZ and 20%AMP+10%PZ solutions. In the present work, the optimal reboiler duty can be reduced to 5.3 GJ/ton CO₂ by using 23%DETA+10%PZ solution as the absorbent at a solvent flow rate of 100 kg/hr.

4. CONCLUSIONS

CSC has designed and constructed the first CO₂ capture pilot plant in Taiwan. The capture efficiency and the capture capacity of CO₂ have achieved the design targets; however, the energy consumption for carbon capture are still above the directive of the European Union in 2005. The reduction in energy consumption for carbon capture needs investigated further by the development of new absorbents. Five absorbents, comprising 20%AMP+10%PZ solution, 20% DETA+10%PZ solution, 23%DETA+20%PZ solution, 20% MEA, and 30% MEA solutions, were

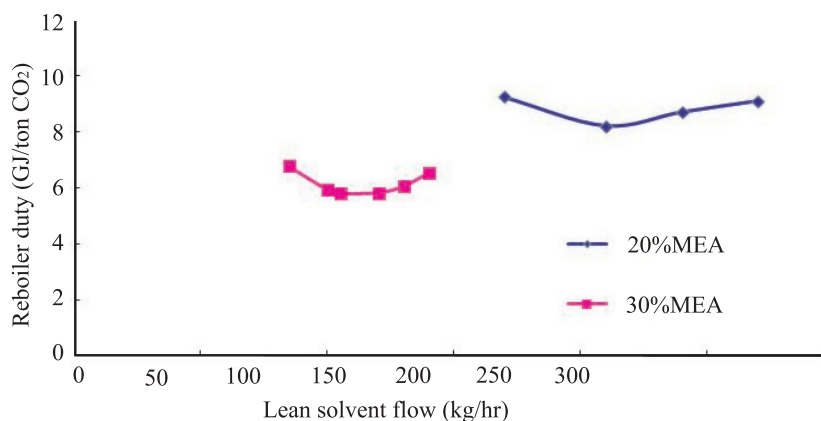
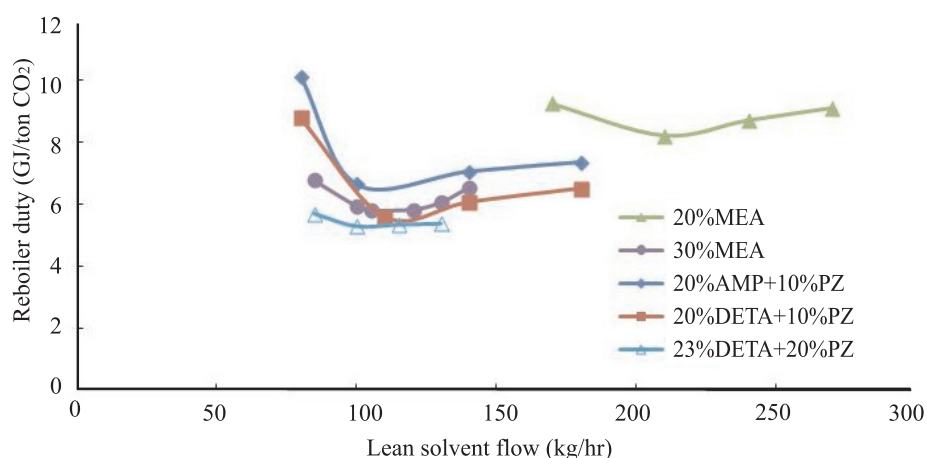

Fig.4. Experimental results of reboiler duty versus various flow rates with 20% and 30%. (stripper pressure: 1 atm)

Table 2 Influence of stripping pressure on reboiler duty for 30% MEA

Operation condition and results	No.1	No. 2	No. 3
Stripper pressure (atm)	1.054	1.303	1.504
CO ₂ concentration at the inlet of absorber (%)	24.2	25.7	27.0
CO ₂ concentration at the outlet of absorber (%)	2.57	3.50	3.62
Flue gas temperature (°C)	27.0	32.0	28.7
Absorbent flow rate (kg/hr)	105	105	105
Absorber temperature (top) (°C)	34.8	35.9	34.6
Absorber temperature (bottom) (°C)	46.9	48.7	48.1
Heat exchanger temperature (°C)	75.2	79.1	81.0
Reboiler (kW)	7.86	7.82	8.10
Flue gas (m ³ /hr)	11.2	11.2	11.2
Absorber pressure (atm)	1.01	1.01	1.00
Stripper temperature (top) (°C)	70.6	71.3	73.3
Stripper temperature (bottom) (°C)	101.5	106.8	111.2
CO ₂ capture amount (kg/day)	108.1	109.9	116.2
CO ₂ capture efficiency (%)	92	90	90
Reboiler duty (GJ/ton CO ₂)	6.28	6.15	6.02

**Fig.5.** Influence of various absorbents on reboiler duty with different solvent flow rate.

chosen to investigate their CO₂ capture properties and to search for the optimal operating parameters to reduce the regeneration energy of CO₂ capture. The experimental results show that the reboiler duty decreases with the increase of MEA concentration and that the optimal reboiler duty exists at a certain flow rate. The optimal reboiler duty for 20% MEA and 30% MEA are 8.2 and 5.8 GJ/ton CO₂, respectively. In addition, the optimal

reboiler duty clearly decreased from 6.28 to 6.02 GJ/ton CO₂ with an increase of stripper pressure from 1 to 1.5 atm. Moreover, the experimental results demonstrated that the blending of different amines is effective for reducing reboiler duty. At the present stage, the optimal reboiler duty can be reduced to 5.3 GJ/ton CO₂ by using 23%DETA+10%PZ solution as the absorbent at a solvent flow rate of 100 kg/hr.

REFERENCES

1. M. Wang, A. Lawal, P. Stephenson, J. Sidders and C. Ramshaw: *Chem. Eng. Res. Des.*, vol. 89 (2011), pp. 1609-24.
2. B. Zhaoa, Y. Su, W. Tao, L. Li and Y. Penga: *Int J Greenh. Gas Control*, vol. 9 (2012), pp. 355-71.
3. B. Beck, J. Garrett, I. Havercroft, D. Wagner and P. Zakkour: *Energy Procedia*, vol. 4 (2011), pp. 5933-40.
4. IPCC, IPCC Fourth Assessment Report: Climate Change 2007 Working Group III, Cambridge University Press, (2007).
5. Paul H. M. Feron: *Int. J. Greenh. Gas Control*, vol. 4 (2010), pp. 152-60.
6. X. He and M. B. Hägg: *J. Membr. Sci.*, vol. 378 (2011), pp. 1-9.
7. IEA: *Prospects for CO₂ capture and storage*, 2004, OECD/IEA.
8. S. Bishnoi: "Carbon Dioxide Absorption and Solution Equilibrium in Piperazine Activated Methyldiethanolamine", The University of Texas at Austin, Austin, Texas, 2000.
9. M. D. Hilliard: "A Predictive Thermodynamic Model for an Aqueous Blend of Potassium Carbonate, Piperazine, and Monoethanolamine for Carbon Dioxide Capture from Flue Gas", The University of Texas at Austin, Austin, Texas, 2008.
10. J. T. Cullinane and G. T. Rochelle: *Fluid Phase Equilibria.*, vol. 227 (2005), pp. 197-213.
11. J. H. Kim, J. H. Lee, I. Y. Lee, K. R. Jang and J. G. Shim: *Energy Procedia*, vol. 4 (2011), pp. 81-84.
12. S. A. Freeman, R. Dugas, et al.: *Energy Procedia*, vol. 1 (2009), pp. 1489-96.
13. T. Wang and K. J. Jens: *Energy Procedia*, vol. 23 (2012), pp.102-10.
14. S. S. Warudkar, K. R. Cox, M. S. Wong and G. J. Hirasaki: *Int. J. Greenh. Gas Control*, vol. 16 (2013), pp. 342-50.
15. B. A. Oyenekan and G. T. Rochelle: *Aiche Journal*, vol. 53 (2007), pp. 3144-54. □